

TPS65133 ± 5 -V, 250-mA Dual-Output Power Supply

1 Features

- 2.9-V to 5.0-V Input Voltage Range
- Fixed 5.0-V Positive Output Voltage (V_{POS})
- Fixed -5.0 -V Negative Output Voltage (V_{NEG})
- $\pm 1\%$ Output Voltage Accuracy
- High Efficiency
- 250-mA Output Current Capability
- Independent Converter Operation Allows 100% Output Current Mismatch
- Excellent Line and Load Transient Response
- Operates in CCM to Minimize Output Noise
- Boost Converter able to Operate with Input Supply Voltages close to 5.0 V
- Short-Circuit Protection
- Thermal Shutdown

2 Applications

- LCD Bias
- AMOLED Supplies
- Operational Amplifier Supplies
- Headphone Amplifier Supplies
- Sensor Front-End Supplies
- Data Acquisition Supplies
- General ± 5 -V Power Supplies

4 Typical Application

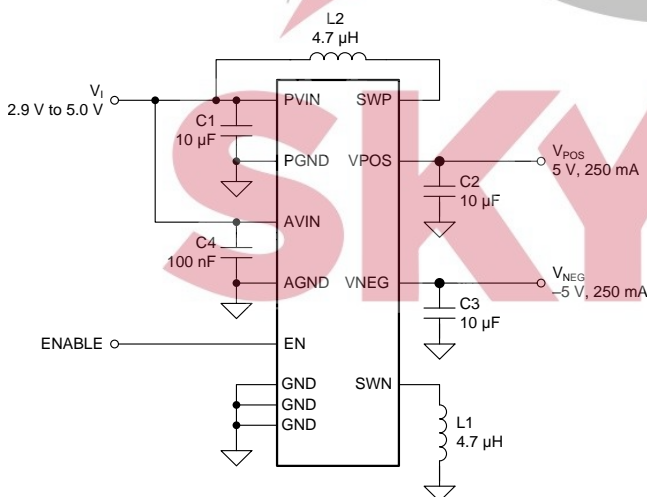

3 Description

The TPS65133 is designed to supply any system requiring ± 5.0 -V supply rails. Each output can supply up to 250 mA of output current. The input supply voltage range is suitable for use with lithium ion batteries or from a fixed 3.3-V supply.

Efficiency is typically over 90% for most applications (operating from a lithium ion battery, output currents in the range 50 mA to 200 mA). The two converters in the TPS65133 device operate independently, allowing 100% mismatch between positive and negative output currents.

Device Information⁽¹⁾

PART NUMBER	PACKAGE	BODY SIZE (NOM)
TPS65133	WSON (12)	3.00 mm x 3.00 mm

(1) For all available packages, see the orderable addendum at the end of the datasheet.

Efficiency

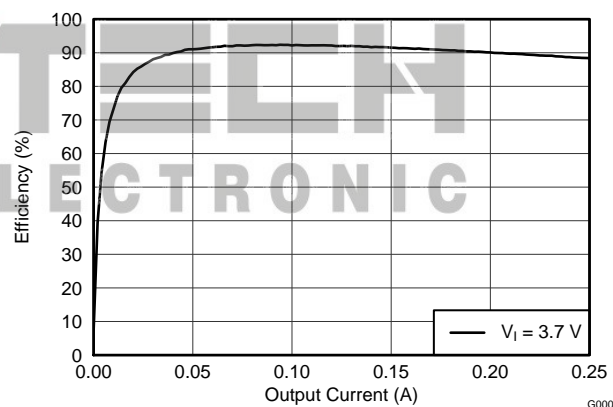

G000



An IMPORTANT NOTICE at the end of this data sheet addresses availability, warranty, changes, use in safety-critical applications, intellectual property matters and other important disclaimers. PRODUCTION DATA.

Table of Contents

1 Features	1	8.3 Feature Description.....	8
2 Applications	1	8.4 Device Functional Modes.....	10
3 Description	1	9 Application and Implementation	11
4 Typical Application	1	9.1 Application Information.....	11
5 Revision History	2	9.2 Typical Application	11
6 Pin Configuration and Functions	3	10 Power Supply Recommendations	16
7 Specifications	4	11 Layout	17
7.1 Absolute Maximum Ratings	4	11.1 Layout Guidelines	17
7.2 ESD Ratings	4	11.2 Layout Example	17
7.3 Recommended Operating Conditions.....	4	12 Device and Documentation Support	18
7.4 Thermal Information	4	12.1 Device Support	18
7.5 Electrical Characteristics.....	5	12.2 Community Resources.....	18
7.6 Switching Characteristics	5	12.3 Trademarks	18
7.7 Typical Characteristics	6	12.4 Electrostatic Discharge Caution.....	18
8 Detailed Description	7	12.5 Glossary	18
8.1 Overview	7	13 Mechanical, Packaging, and Orderable Information	18
8.2 Functional Block Diagram	7		

5 Revision History

NOTE: Page numbers for previous revisions may differ from page numbers in the current version.

Changes from Original (June 2013) to Revision A	Page
<ul style="list-style-type: none"> • Added Device Information table, ESD Ratings table, Switching Characteristics table, Feature Description section, Device Functional Modes, Application and Implementation section, Power Supply Recommendations section, Device and Documentation Support section, and Mechanical, Packaging, and Orderable Information section. 	1
<ul style="list-style-type: none"> • Changed Layout Example 	17



6 Pin Configuration and Functions

**DPD Package
12-Pin WSON
(Top View)**

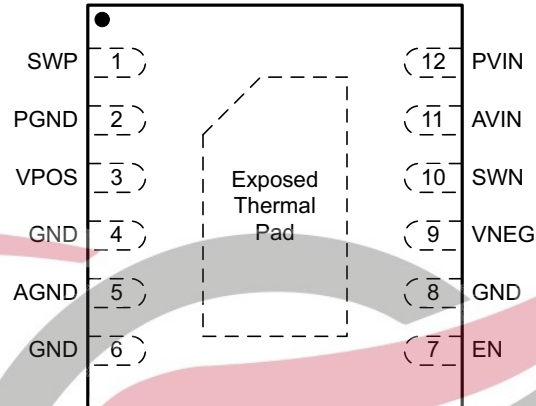

Pin Functions

PIN		DESCRIPTION
NAME	NO.	
AGND	5	Analog ground
AVIN	11	Internal logic supply pin
EN	7	Enable of boost and buck-boost converter
GND	4, 6, 8	Ground
SWP	1	Switch pin of the boost converter
PGND	2	Power ground of the boost converter
PVIN	12	Supply pin for the negative buck-boost converter. Place a capacitor close to this pin.
SWN	10	Switch pin of the negative buck-boost converter
VNEG	9	Output of the negative buck-boost converter (V_{NEG}), place a capacitor close to this pin.
VPOS	3	Output of the boost converter (V_{POS}), place a capacitor close to this pin.
Exposed thermal pad		Exposed thermal pad. Connect this pad to all GND pins.

SKYTECH
ELECTRONIC

7 Specifications

7.1 Absolute Maximum Ratings⁽¹⁾

over operating free-air temperature range (unless otherwise noted)

		MIN	MAX	UNIT
Input voltage ⁽²⁾	PVIN, AVIN, EN, SWP, VPOS	-0.3	6	V
	VNEG	-6.5	0.3	V
	SWN	-6.5	5.5	V
Junction temperature, T _J		-40	150	°C
Storage temperature, T _{stg}		-65	150	°C

- (1) Stresses beyond those listed under “absolute maximum ratings” may cause permanent damage to the device. These are stress ratings only and functional operation of the device at these or any other conditions beyond those indicated under “recommended operating conditions” is not implied. Exposure to absolute-maximum-rated conditions for extended periods may affect device reliability.
- (2) With respect to GND pin.

7.2 ESD Ratings

		VALUE	UNIT
V _(ESD)	Electrostatic discharge	Human-body model (HBM), per ANSI/ESDA/JEDEC JS-001 ⁽¹⁾	±2000
		Charged-device model (CDM), per JEDEC specification JESD22-C101 ⁽²⁾	±500

- (1) JEDEC document JEP155 states that 500-V HBM allows safe manufacturing with a standard ESD control process.
- (2) JEDEC document JEP157 states that 250-V CDM allows safe manufacturing with a standard ESD control process.

7.3 Recommended Operating Conditions⁽¹⁾

over operating free-air temperature range (unless otherwise noted)

		MIN	NOM	MAX	UNIT
V _I	Input voltage	2.9	3.7	5	V
T _A	Operating ambient temperature	-40		85	°C
T _J	Operating junction temperature	-40		125	°C

- (1) Refer to the [Application Information](#) section for additional information.

7.4 Thermal Information

THERMAL METRIC ⁽¹⁾		TPS65133	UNIT
		DPD (WSON)	
R _{θJA}	Junction-to-ambient thermal resistance	51.5	°C/W
R _{θJC(top)}	Junction-to-case (top) thermal resistance	41.7	
R _{θJB}	Junction-to-board thermal resistance	25	
ψ _{JT}	Junction-to-top characterization parameter	0.5	
ψ _{JB}	Junction-to-board characterization parameter	25.2	
R _{θJC(bot)}	Junction-to-case (bottom) thermal resistance	4.4	

- (1) For more information about traditional and new thermal metrics, see the *IC Package Thermal Metrics* application report, [SPRA953](#).

7.5 Electrical Characteristics

$V_I = 3.7\text{ V}$, $EN = V_I$, $V_{POS} = 5.0\text{ V}$, $V_{NEG} = -5.0\text{ V}$, $T_A = -40^\circ\text{C}$ to 85°C , typical values are at $T_A = 25^\circ\text{C}$ (unless otherwise noted)

PARAMETER		TEST CONDITIONS	MIN	TYP	MAX	UNIT
SUPPLY CURRENT AND THERMAL PROTECTION						
V_I	Input voltage		2.9		5	V
	Shut down supply current	$EN = \text{GND}$ $I_{(IN)} = I_{(AVIN)} + I_{(PVIN)} + I_{(SWP)}$		0.1	15	μA
	Undervoltage lockout threshold	V_I falling			2.1	V
	Undervoltage lockout threshold	V_I rising			2.5	V
	Thermal shutdown temperature			135		$^\circ\text{C}$
LOGIC SIGNALS (EN)						
	High-level input voltage		1.2			V
	Low-level input voltage				0.4	V
BOOST CONVERTER (V_{POS})						
V_{POS}	Output voltage		4.95	5	5.05	V
	Low-side MOSFET on-state resistance	$I_{(SWP)} = 200\text{ mA}$		250		$\text{m}\Omega$
	High-side MOSFET on-state resistance	$I_{(SWP)} = -200\text{ mA}$		350		
	High-side MOSFET current limit	Inductor valley current	0.8	1.1		A
$V_{(SCP)(P)}$	Short-circuit threshold in operation	V_{POS} falling		4.1		V
	Active discharge resistance	$EN = \text{GND}$; $I_{(VPOS)} = 1\text{ mA}$	15	30	60	Ω
	Line regulation	$I_{POS} = 100\text{ mA}$		0.02		%/V
	Load regulation			0.24		%/A
BUCK-BOOST CONVERTER (V_{NEG})						
V_{NEG}	Negative output voltage default		-5.05	-5	-4.95	V
	High-side MOSFET on-state resistance	$I_{(SWN)} = -200\text{ mA}$		250		$\text{m}\Omega$
	Low-side MOSFET on-state resistance	$I_{(SWN)} = 200\text{ mA}$		350		
	Low-side MOSFET current limit	Inductor valley current	1.5	2.2		A
$V_{(SCP)(N)}$	Short-circuit threshold in operation			-4.5		V
	Active discharge resistance	$EN = \text{GND}$; $I_{(VNEG)} = -1\text{ mA}$	100	150	200	Ω
	Line regulation	$I_{NEG} = -100\text{ mA}$		0.01		%/V
	Load regulation			0.16		%/A

7.6 Switching Characteristics

over operating free-air temperature range (unless otherwise noted)

PARAMETER		TEST CONDITIONS	MIN	TYP	MAX	UNIT
BOOST CONVERTER (V_{POS})						
	Switching frequency	$I_{POS} = 200\text{ mA}$	1.2	1.7	2.2	MHz
	Short-circuit detection time	The delay from when $V_{POS} < V_{(SCP)(P)}$ to when the boost converter turns off	1	3	5	ms
BUCK-BOOST CONVERTER (V_{NEG})						
	Switching frequency	$I_{NEG} = -200\text{ mA}$	1	1.7	2.4	MHz
	Short-circuit detection time	The delay from when $V_{NEG} > V_{(SCP)(N)}$ to when the inverting buck-boost converter turns off	1	3	5	ms
	Start-up delay	The delay from when V_{POS} has reached its target value to when V_{NEG} starts ramping		2		ms

7.7 Typical Characteristics

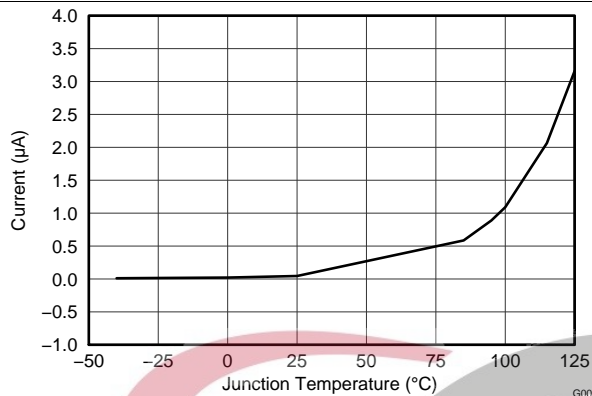

Figure 1. Shutdown Current into AVIN and PVIN

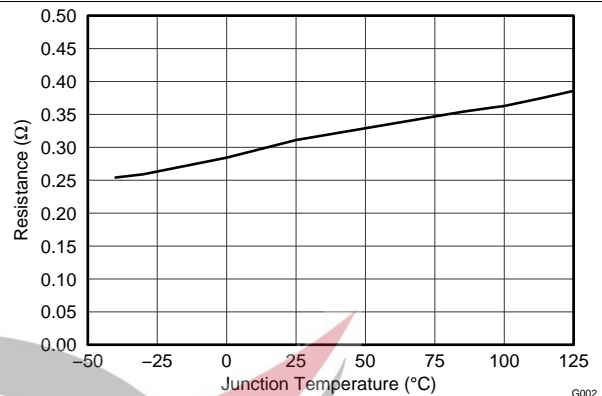

Figure 2. Boost Converter Switch $r_{DS(on)}$

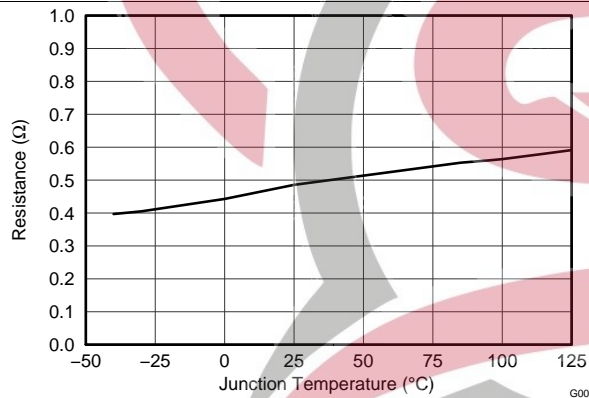

Figure 3. Boost Converter Rectifier $r_{DS(on)}$

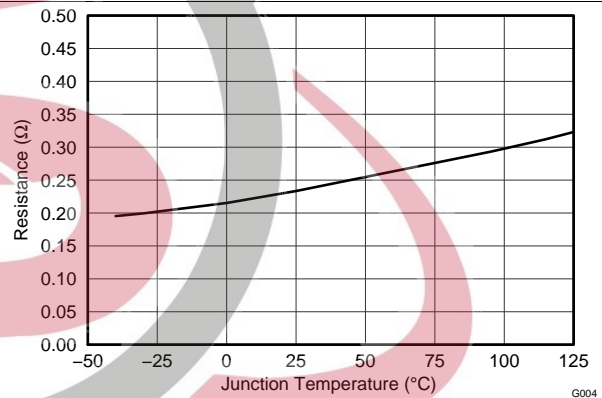

Figure 4. Inverting Buck-Boost Converter Switch $r_{DS(on)}$

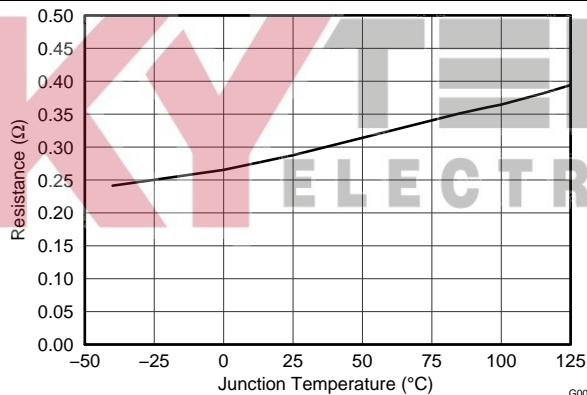

Figure 5. Inverting Buck-Boost Converter Rectifier $r_{DS(on)}$

8 Detailed Description

8.1 Overview

The TPS65133 device comprises a boost converter and an inverting buck-boost converter. The boost converter generates a positive output voltage of 5.0 V and the inverting buck-boost converter generates a negative output voltage of -5.0 V. Both converters have an output voltage accuracy of $\pm 1\%$.

8.2 Functional Block Diagram

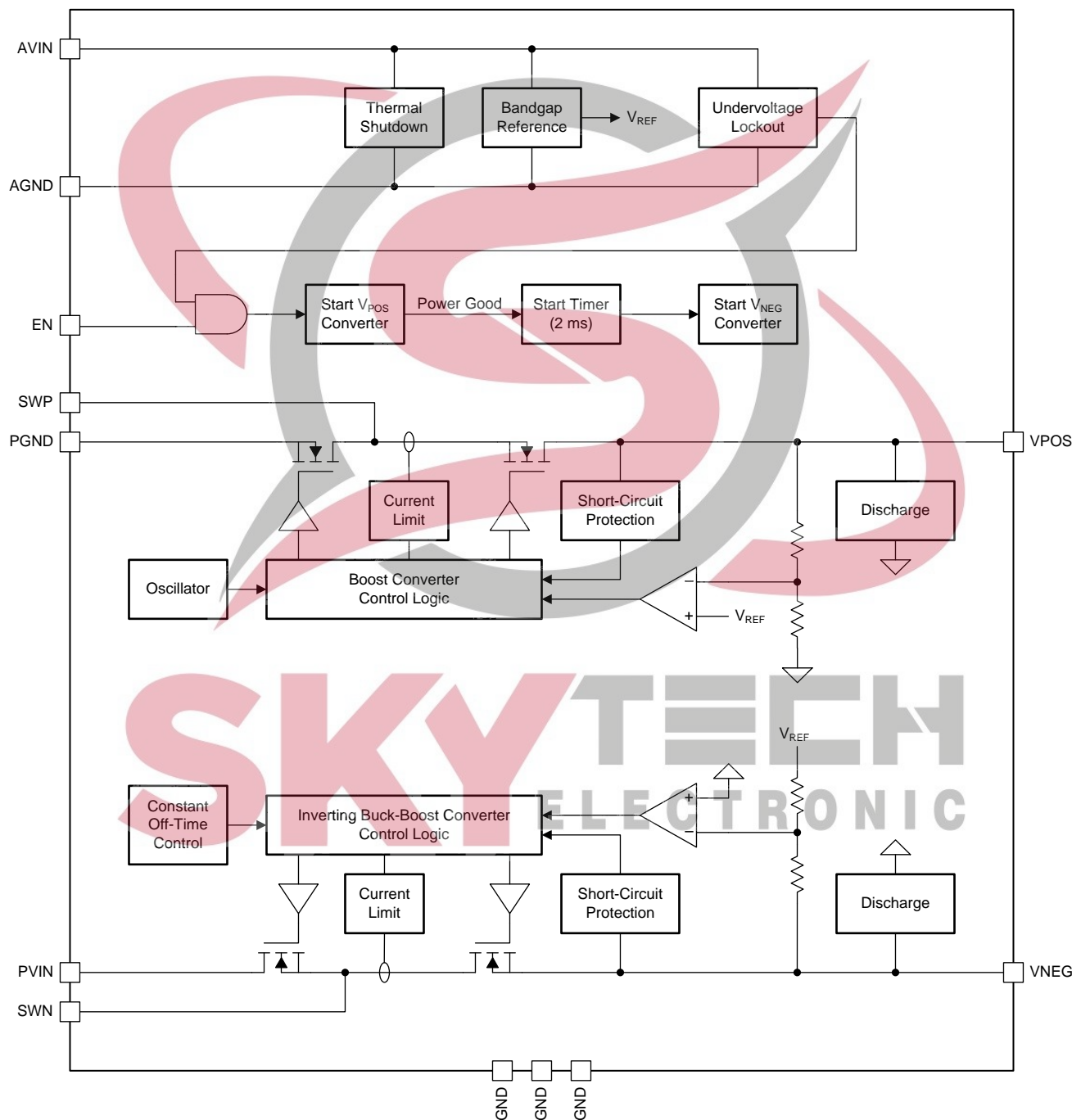

8.3 Feature Description

8.3.1 Boost Converter (V_{POS})

The boost converter uses a current-mode topology with synchronous rectification (see [Figure 6](#)). The synchronous rectifier improves efficiency and provides input-output isolation when the converter is disabled. When the input supply voltage is close 5.0 V, preventing normal boost operation, the synchronous rectifier is disabled, allowing the output voltage regulation to be maintained (see [Operation with \$V_I \approx V_{POS}\$ \(Diode Mode\)](#)).

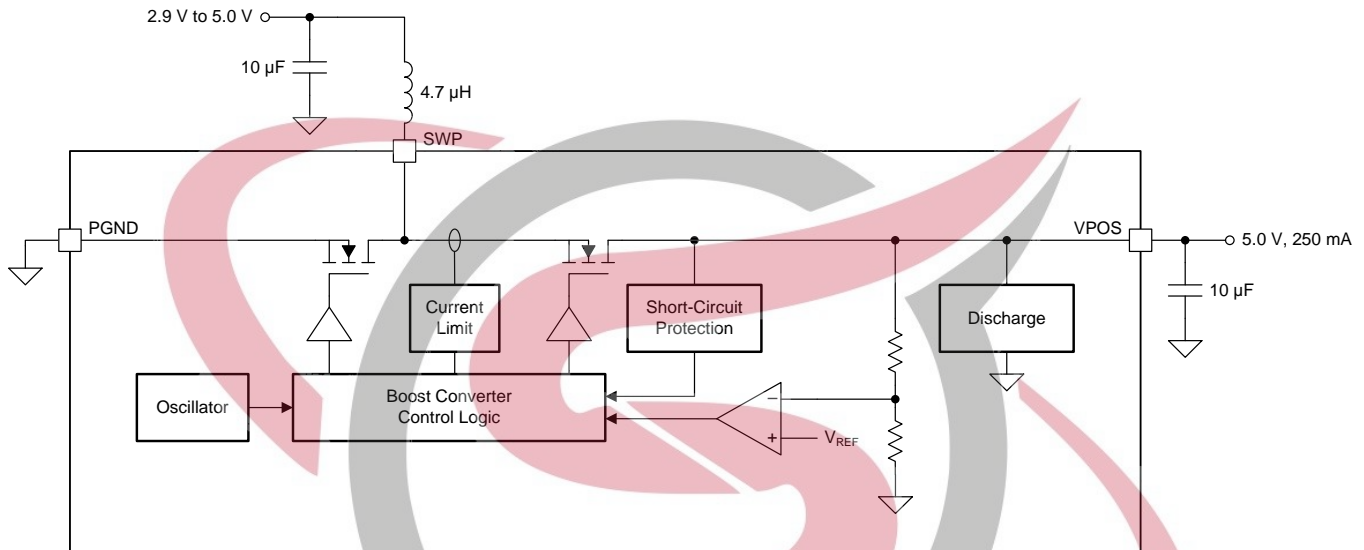

Figure 6. V_{POS} Boost Converter Internal Block Diagram

8.3.1.1 Switching Frequency (V_{POS})

The boost converter switching frequency may vary slightly as the operating conditions change, but is typically around 1.7 MHz for most operating conditions.

8.3.1.2 Output Voltage (V_{POS})

The boost converter's output voltage is factory-programmed to 5.0 V \pm 1.0% and cannot be changed by the user.

8.3.1.3 Startup (V_{POS})

The boost converter starts up as soon as EN=HIGH and the input supply voltage is above the UVLO threshold. The converter features an integrated soft-start function to control the ramp of its output voltage.

8.3.1.4 Shutdown (V_{POS})

The boost converter shuts down when EN=LOW or the input supply voltage falls below the UVLO threshold.

8.3.1.5 Active Discharge (V_{POS})

The boost converter output is actively discharged to ground when the converter is disabled (see [Figure 8](#)). During startup, active discharge begins as soon as the input supply voltage is above the UVLO threshold. During shutdown, active discharge persists until the input supply voltage is too low to support its operation ($V_I \approx 1.5$ V).

8.3.1.6 Short-Circuit Protection (V_{POS})

The boost converter is protected against short-circuits on its output. If a short-circuit condition is detected during start-up, the converter limits its output current until the short-circuit condition is removed. Note that if a boost converter short-circuit condition is detected during start-up, the inverting buck-boost converter will not start until the condition is removed (because the sequencing logic requires V_{POS} to be in regulation before the inverting buck-boost converter is started).

Feature Description (continued)

During normal operation the boost converter detects a short-circuit on its output if $V_{POS} < 4.1$ V for longer than 3 ms. When a short-circuit condition is detected both V_{POS} and V_{NEG} are disabled and the device shuts down. Normal operation is resumed by pulling EN low and then high again, or by cycling the input supply voltage.

8.3.2 Inverting Buck-Boost Converter (V_{NEG})

The inverting buck-boost converter uses a current-mode topology with synchronous rectification (see Figure 7).

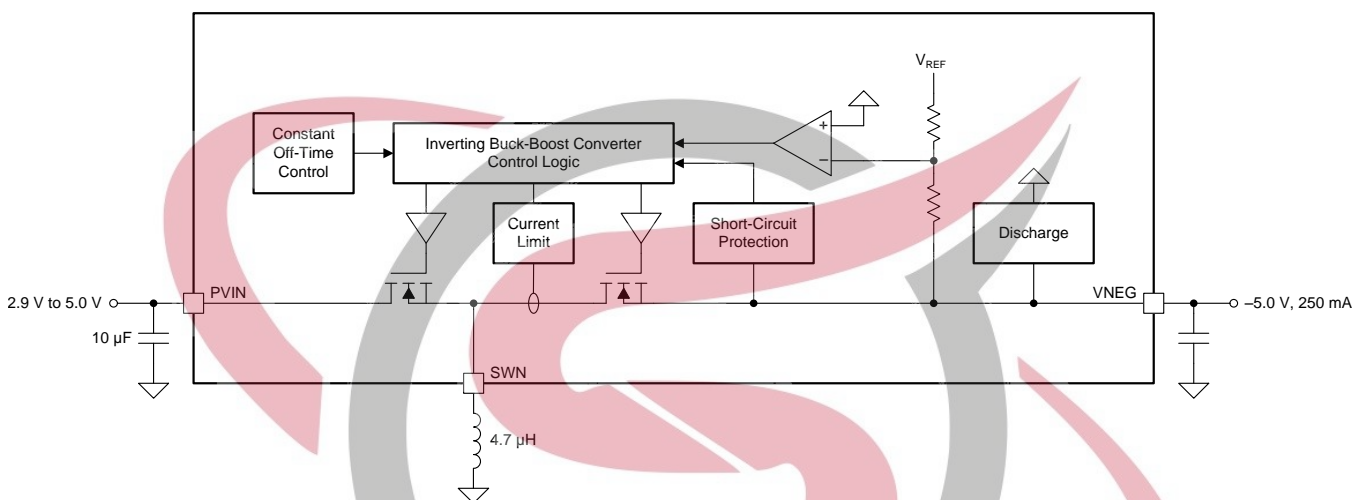

Figure 7. V_{NEG} Buck-Boost Converter Internal Block Diagram

8.3.2.1 Switching Frequency (V_{NEG})

The inverting buck-boost converter's switching frequency varies slightly with operating conditions, but is approximately 1.7 MHz for most operating conditions.

8.3.2.2 Output Voltage (V_{NEG})

The inverting buck-boost converter's output voltage is factory-programmed to -5.0 V $\pm 1.0\%$ and cannot be changed by the user.

8.3.2.3 Startup (V_{NEG})

The inverting buck-boost converter starts up approximately 2 ms after the boost converter output has reached 5.0 V. The converter's switch current is limited during startup and the output voltage ramps in a controlled manner.

8.3.2.4 Shutdown

The inverting buck-boost converter shuts down when EN=LOW or the input supply voltage falls below the UVLO threshold.

8.3.2.5 Active Discharge (V_{NEG})

The inverting buck-boost converter output is actively discharged to ground when the converter is disabled (see Figure 8). During startup, active discharge begins as soon as the input supply voltage is above the UVLO threshold. During shutdown, active discharge persists until the input supply voltage is too low to support its operation ($V_I \approx 1.5$ V).

8.3.2.6 Short-Circuit Protection (V_{NEG})

The inverting buck-boost converter is protected against short-circuits on its output. If a short-circuit condition is detected during startup, the device converter limits its output current until the short-circuit condition is removed.

Feature Description (continued)

During normal operation the inverting buck-boost converter detects a short-circuit on its output if $V_{NEG} > -4.5$ V for longer than 3 ms. When a short-circuit condition is detected both V_{POS} and V_{NEG} are disabled and the device shuts down. Normal operation is resumed by pulling EN low and then high again, or by cycling the input supply voltage.

8.3.3 Startup and Shutdown Sequencing

Figure 8 illustrates the startup and shutdown sequencing of the TPS65133 device.

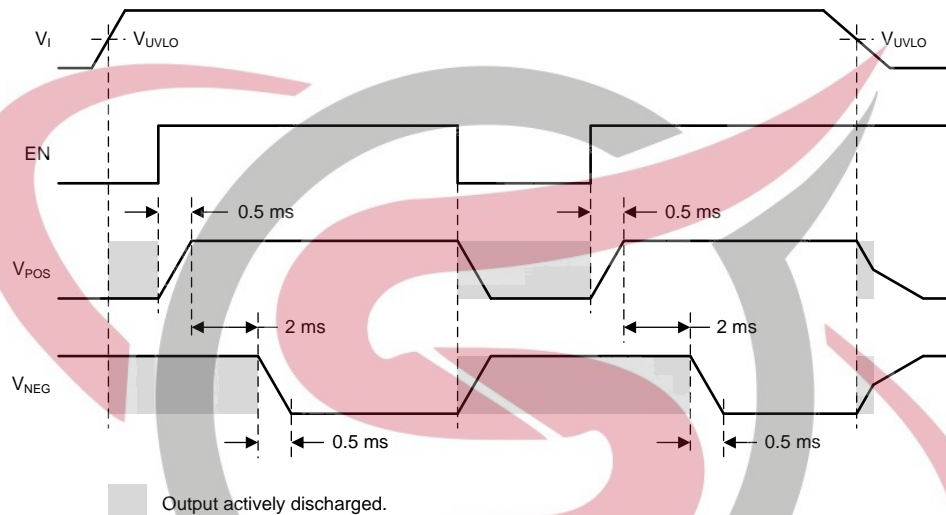

Figure 8. Startup and Shutdown Sequencing

8.3.4 Thermal Shutdown

The TPS65133 device features a thermal shutdown function to prevent damage because of excessive temperature. Once a junction temperature of 135°C (typical) is exceeded the device goes into shuts down. Normal operation is resumed (assuming that the device junction temperature has fallen below the thermal shut-down threshold) by pulling EN low and then high again, or by cycling the input supply voltage.

8.4 Device Functional Modes

8.4.1 Operation with $V_I < 2.9$ V

The recommended minimum input supply voltage is 2.9 V. The device continues to operate with input supply voltages below 2.9 V, however, full performance is not guaranteed. The device does not operate with input supply voltages below the UVLO threshold.

8.4.2 Operation with $V_I \approx V_{POS}$ (Diode Mode)

The TPS65133 device features a "diode" mode that enables it to regulate its positive output even when the input supply voltage is close to 5.0 V (i.e. too high for normal boost operation). When operating in diode mode the converter's synchronous rectifier stops switching and instead its body diode is used to rectify the output current. Boost converter efficiency is reduced in diode mode. At low output currents (≈ 2 mA and below), the boost converter automatically transitions from pulse-width modulation to pulse-skip operation. This ensures that the boost converter's output stays in regulation, but increases the voltage ripple on V_{POS} .

8.4.3 Operation with EN

When EN=LOW the TPS65133 device is disabled and switching is inhibited. When the input supply voltage is above the undervoltage lockout and EN=HIGH the device is enabled and its start-up sequence begins.

9 Application and Implementation

NOTE

Information in the following applications sections is not part of the TI component specification, and TI does not warrant its accuracy or completeness. TI's customers are responsible for determining suitability of components for their purposes. Customers should validate and test their design implementation to confirm system functionality.

9.1 Application Information

The TPS65133 device can be used to generate $\pm 5\text{-V}$ supply rails from input supply voltages in the range 2.9 V to 5 V, and has been optimized for use with regulated 3.3-V rails and single-cell Li-Ion batteries. Its output voltages are fixed at $\pm 5\text{ V}$ and cannot be changed by the user. Both output voltages are controlled by the EN pin: a high logic level on the EN pin enables both outputs, and a low logic level disables them. Note that when the input supply voltage is above the UVLO threshold and the EN pin is low, both outputs are disabled and *actively discharged* to ground. When the input supply voltage is below the UVLO threshold, both outputs are disabled, but they are *not* actively discharged.

9.2 Typical Application

Figure 9 shows a typical application schematic suitable for supplying up to 250 mA at $\pm 5\text{ V}$ from e.g. a single-cell Li-Ion battery.

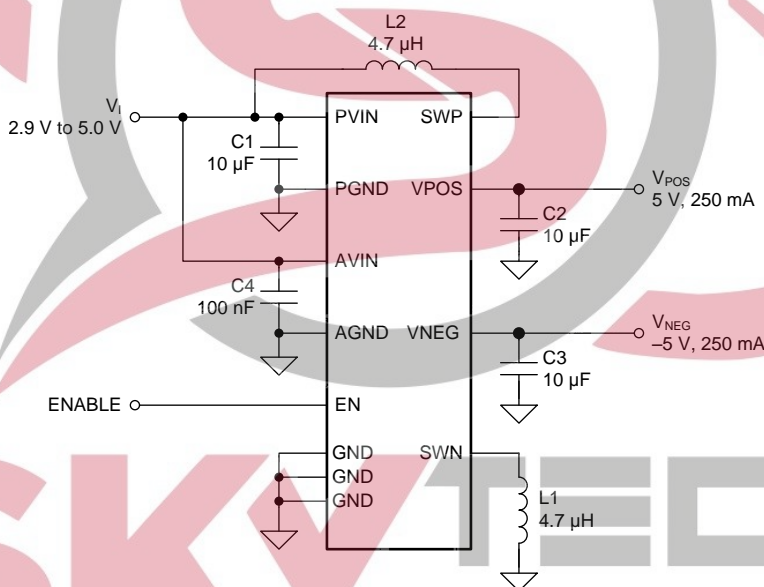

Figure 9. Typical Application Circuit

9.2.1 Design Requirements

The design parameters for the application circuit in Figure 9 are listed in Table 1.

Table 1. Design Parameters

PARAMETERS	EXAMPLE VALUES
Input voltage range	2.9 V to 5.0 V
Output voltage	$\pm 5.0\text{ V}$
Switching frequency	1.7 MHz

9.2.2 Detailed Design Procedure

In order to maximize performance, the TPS65133 device has been optimized for use with a relatively narrow range of external components, and customers are recommended to use the application circuit shown in Figure 9 and the components listed in Table 2 and Table 3.

9.2.2.1 Inductor Selection

The two dc-dc converters in the TPS65133 device have been optimized for use with 4.7 μH inductors, and it is recommended to use this value in all applications. Customers using different values of inductors should characterize performance thoroughly before going to mass production.

Table 2. Inductor Selection

PARAMETER	VALUE	MANUFACTURER	PART NUMBER
L1, L2	4.7 μH	Coilmaster	MMPP252012-4R7N
		Toko	1239AS-H-4R7M
		ABCO	LPP252012-4R7N
		Coilcraft	XFL4020-4R7ML

9.2.2.2 Capacitor Selection

The recommended capacitor values are shown in Table 3. Applications using less than the recommended capacitance (e.g. to save PCB area) may experience increased voltage ripple. In general, the lower the output power required by the application, the lower the capacitance needed for proper performance. C4 improves immunity to noise on the input supply voltage, but it is not necessary in many applications.

Table 3. Capacitor Selection

PARAMETER	VALUE	MANUFACTURER	PART NUMBER
C1, C2, C3	10 μF	Murata	GRM21BR71A106KE51
C4	100 nF		GRM21BR71E104KA01

9.2.3 Application Performance Graphs

The performance shown in the following graphs was obtained using the circuit shown in Figure 9 and the external components listed in Table 2 and Table 3. ⁽¹⁾

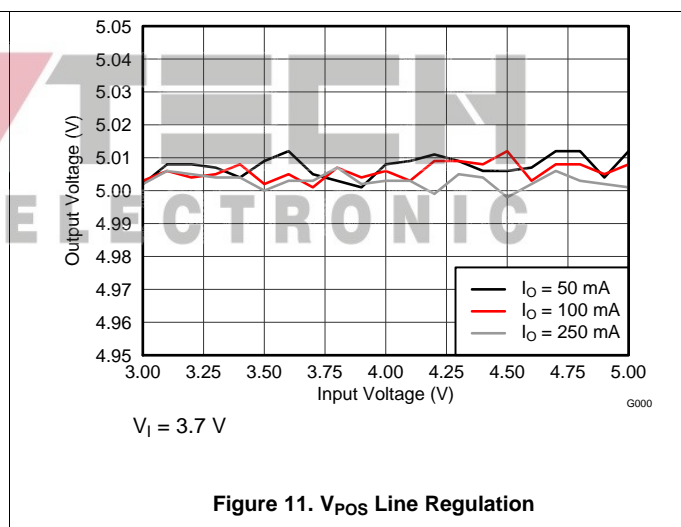
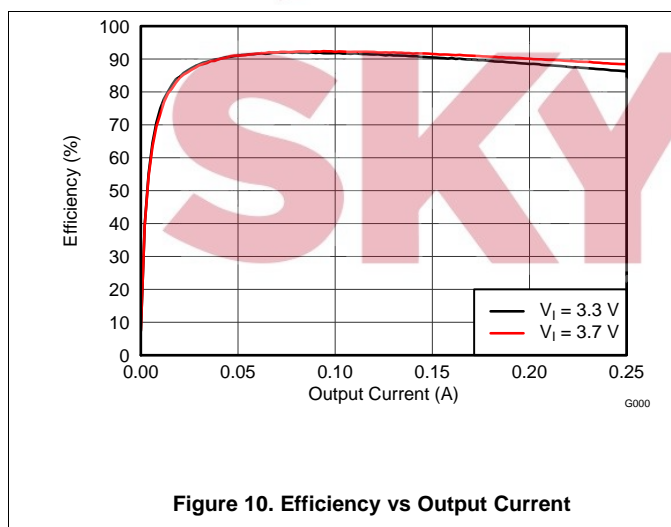

(1) The Toko inductor was used to obtain the application graphs.

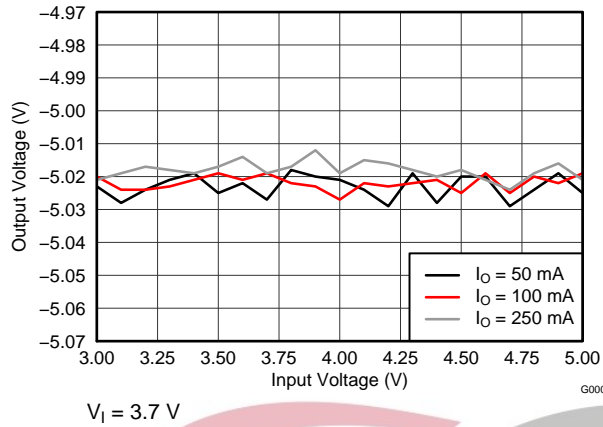

Figure 12. V_{NEG} Line Regulation

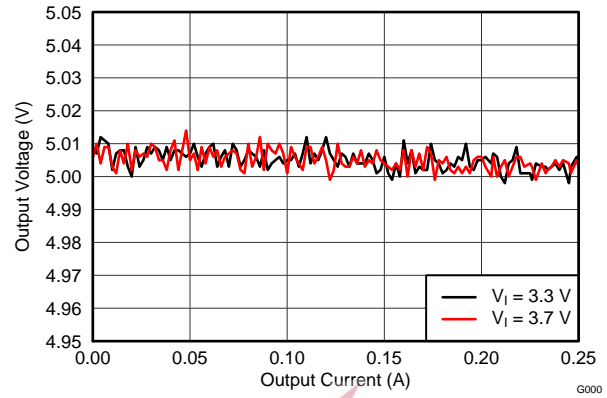

Figure 13. V_{POS} Load Regulation

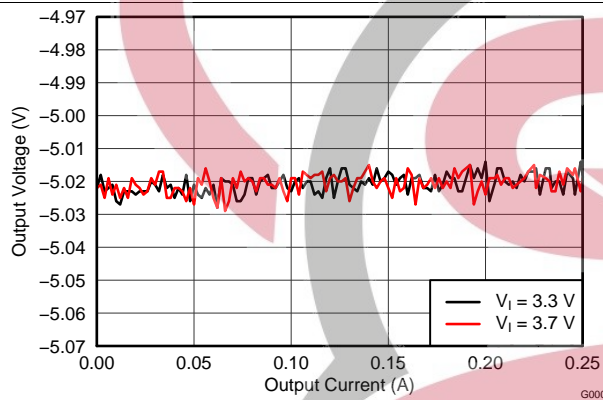

Figure 14. V_{NEG} Load Regulation

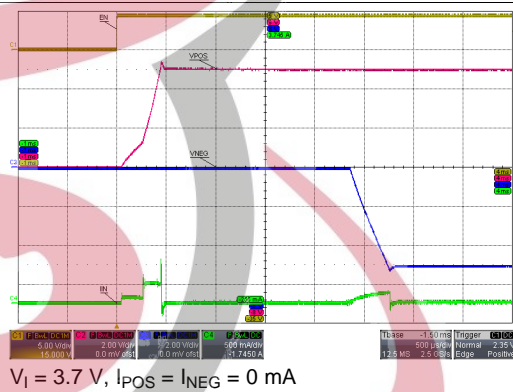

Figure 15. V_{POS} and V_{NEG} Startup Behavior (0 mA)

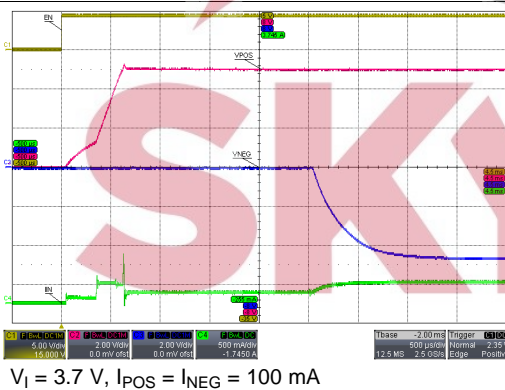

Figure 16. V_{POS} and V_{NEG} Startup Behavior (100 mA)

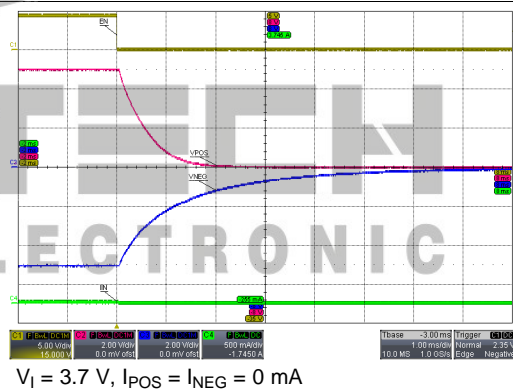
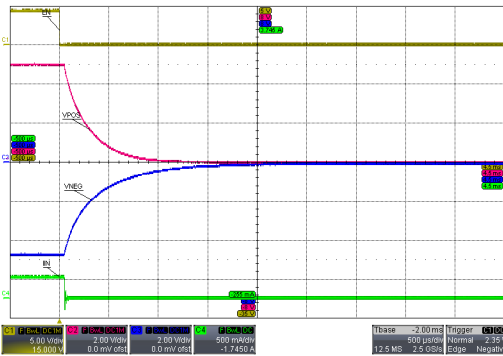
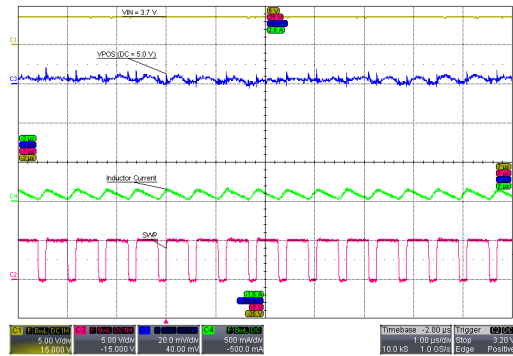

Figure 17. V_{POS} and V_{NEG} Shutdown Behavior (0 mA)



$V_I = 3.7\text{ V}$, $I_{POS} = I_{NEG} = 100\text{ mA}$

Figure 18. V_{POS} and V_{NEG} Shutdown Behavior (100 mA)



$V_I = 3.7\text{ V}$, $I_{POS} = 10\text{ mA}$

Figure 19. V_{POS} Switching Waveforms (10 mA)

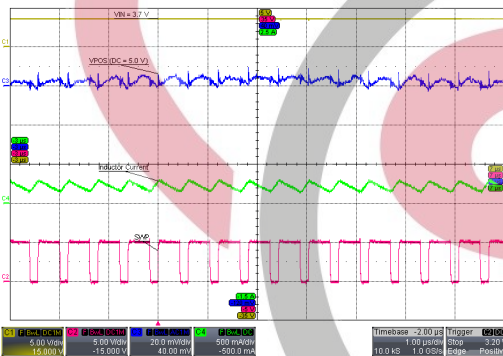

$V_I = 3.7\text{ V}$, $I_{POS} = 100\text{ mA}$

Figure 20. V_{POS} Switching Waveforms (100 mA)

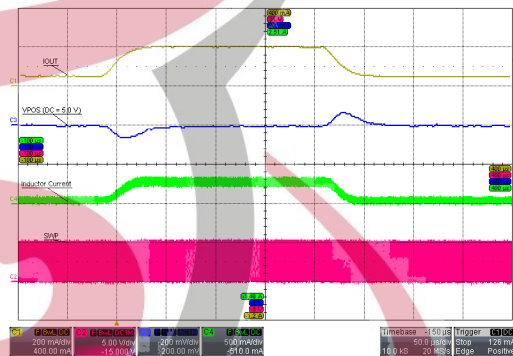

$V_I = 3.7\text{ V}$, $I_{POS} = 50\text{ mA}$ to 200 mA

Figure 21. V_{POS} Load Transient

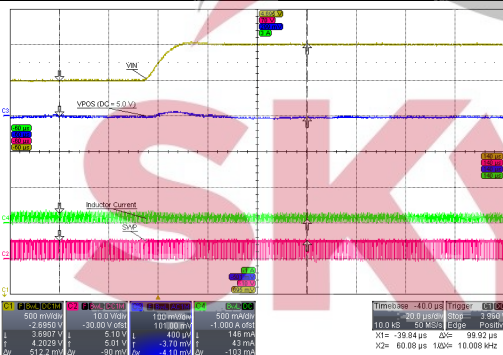

$V_I = 3.7\text{ V}$ to 4.2 V , $I_{POS} = 50\text{ mA}$

Figure 22. V_{POS} Line Transient

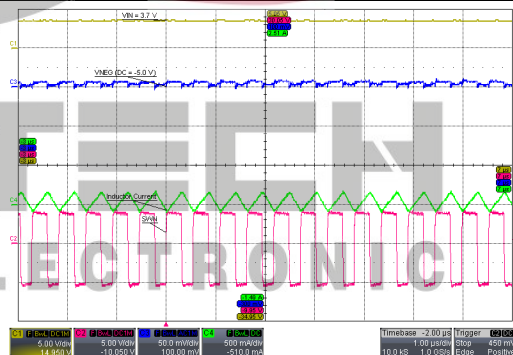

$V_I = 3.7\text{ V}$, $I_{NEG} = 10\text{ mA}$

Figure 23. V_{NEG} Switching Waveforms (10 mA)

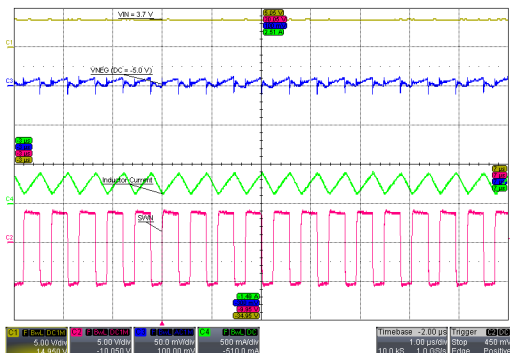

$V_I = 3.7\text{ V}$, $I_{NEG} = 100\text{ mA}$

Figure 24. V_{NEG} Switching Waveforms (100 mA)

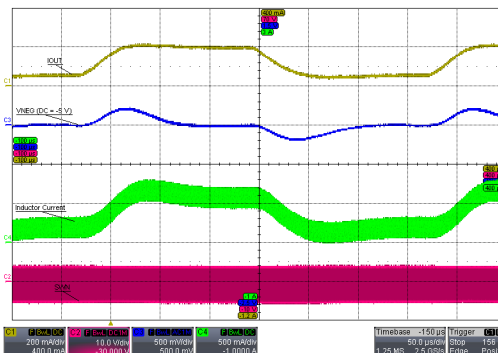

$V_I = 3.7\text{ V}$, $I_{NEG} = 50\text{ mA to }200\text{ mA}$

Figure 25. V_{NEG} Load Transient

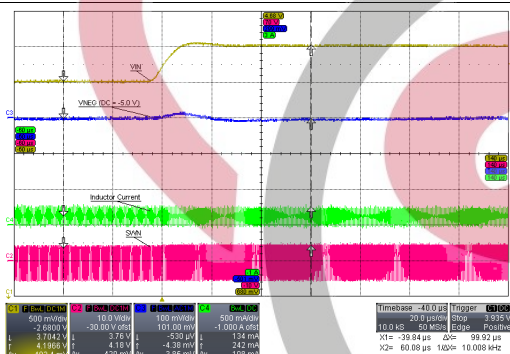

$V_I = 3.7\text{ V to }4.2\text{ V}$, $I_{NEG} = 50\text{ mA}$

Figure 26. V_{NEG} Line Transient

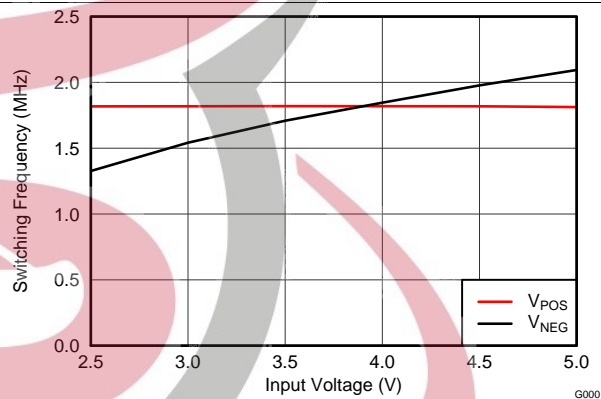

$I_{POS} = I_{NEG} = 100\text{ mA}$

Figure 27. Switching Frequency



10 Power Supply Recommendations

The TPS65133 device is designed to operate from an input supply voltage in the range 2.9 V to 5.0 V. If the input supply is located more than a few centimeters from the device additional bulk capacitance may be required. The 10- μ F shown in the schematics in this data sheet are typical for this function.



11 Layout

11.1 Layout Guidelines

No PCB layout is perfect, and compromises are always necessary. However, the basic principles listed below (in order of importance) go a long way to achieving the full performance of the TPS65133 device.

- Route discontinuous switching currents on the top layer using short, wide traces. Avoid routing these signals through vias, which have relatively high parasitic inductance and resistance.
- Place C1 as close as possible to pin 12.
- Place C2 as close as possible to pin 3. Place C3 as close as possible to pin 9.
- Use the exposed thermal pad to connect GND, AGND and PGND.
- Use a copper pour (preferably on layer 2) as a thermal spreader and connect it to the exposed thermal pad using a number of thermal vias.

Figure 28 illustrates how a PCB layout following the above principles may be realized in practice.

11.2 Layout Example

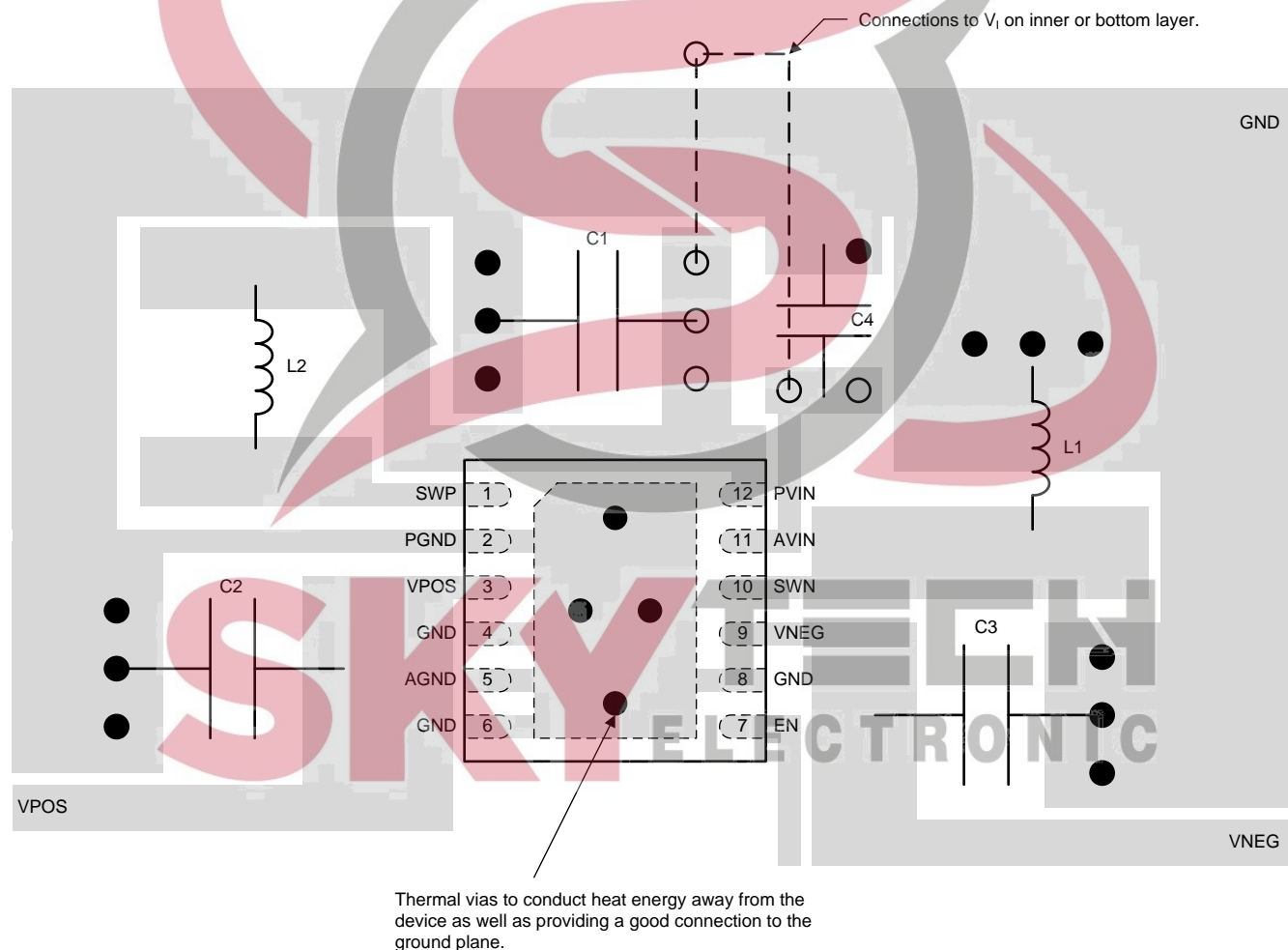

- Via to signal layer on internal or bottom layer.
- Via to copper pour ground plane on internal or bottom layer.

Figure 28. PCB Layout Example

12 Device and Documentation Support

12.1 Device Support

12.1.1 Third-Party Products Disclaimer

TI'S PUBLICATION OF INFORMATION REGARDING THIRD-PARTY PRODUCTS OR SERVICES DOES NOT CONSTITUTE AN ENDORSEMENT REGARDING THE SUITABILITY OF SUCH PRODUCTS OR SERVICES OR A WARRANTY, REPRESENTATION OR ENDORSEMENT OF SUCH PRODUCTS OR SERVICES, EITHER ALONE OR IN COMBINATION WITH ANY TI PRODUCT OR SERVICE.

12.2 Community Resources

The following links connect to TI community resources. Linked contents are provided *AS IS* by the respective contributors. They do not constitute TI specifications and do not necessarily reflect TI's views; see TI's [Terms of Use](#).

TI E2E™ Online Community *TI's Engineer-to-Engineer (E2E) Community*. Created to foster collaboration among engineers. At e2e.ti.com, you can ask questions, share knowledge, explore ideas and help solve problems with fellow engineers.

Design Support *TI's Design Support* Quickly find helpful E2E forums along with design support tools and contact information for technical support.

12.3 Trademarks

E2E is a trademark of Texas Instruments.
All other trademarks are the property of their respective owners.

12.4 Electrostatic Discharge Caution



These devices have limited built-in ESD protection. The leads should be shorted together or the device placed in conductive foam during storage or handling to prevent electrostatic damage to the MOS gates.

12.5 Glossary

[SLYZ022](#) — *TI Glossary*.

This glossary lists and explains terms, acronyms, and definitions.

13 Mechanical, Packaging, and Orderable Information

The following pages include mechanical, packaging, and orderable information. This information is the most current data available for the designated devices. This data is subject to change without notice and revision of this document. For browser-based versions of this data sheet, refer to the left-hand navigation.

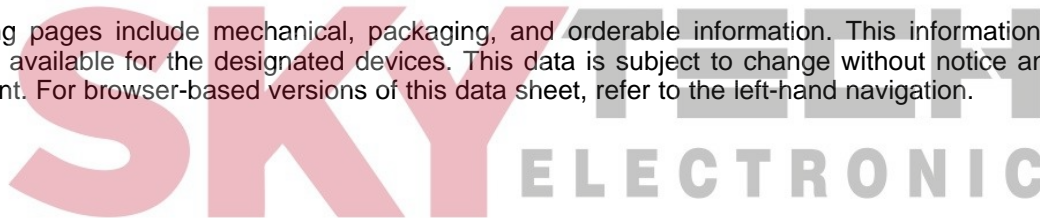

DPD0012A

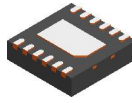

PACKAGE OUTLINE

WSON - 0.8 mm max height

PLASTIC SMALL OUTLINE - NO LEAD

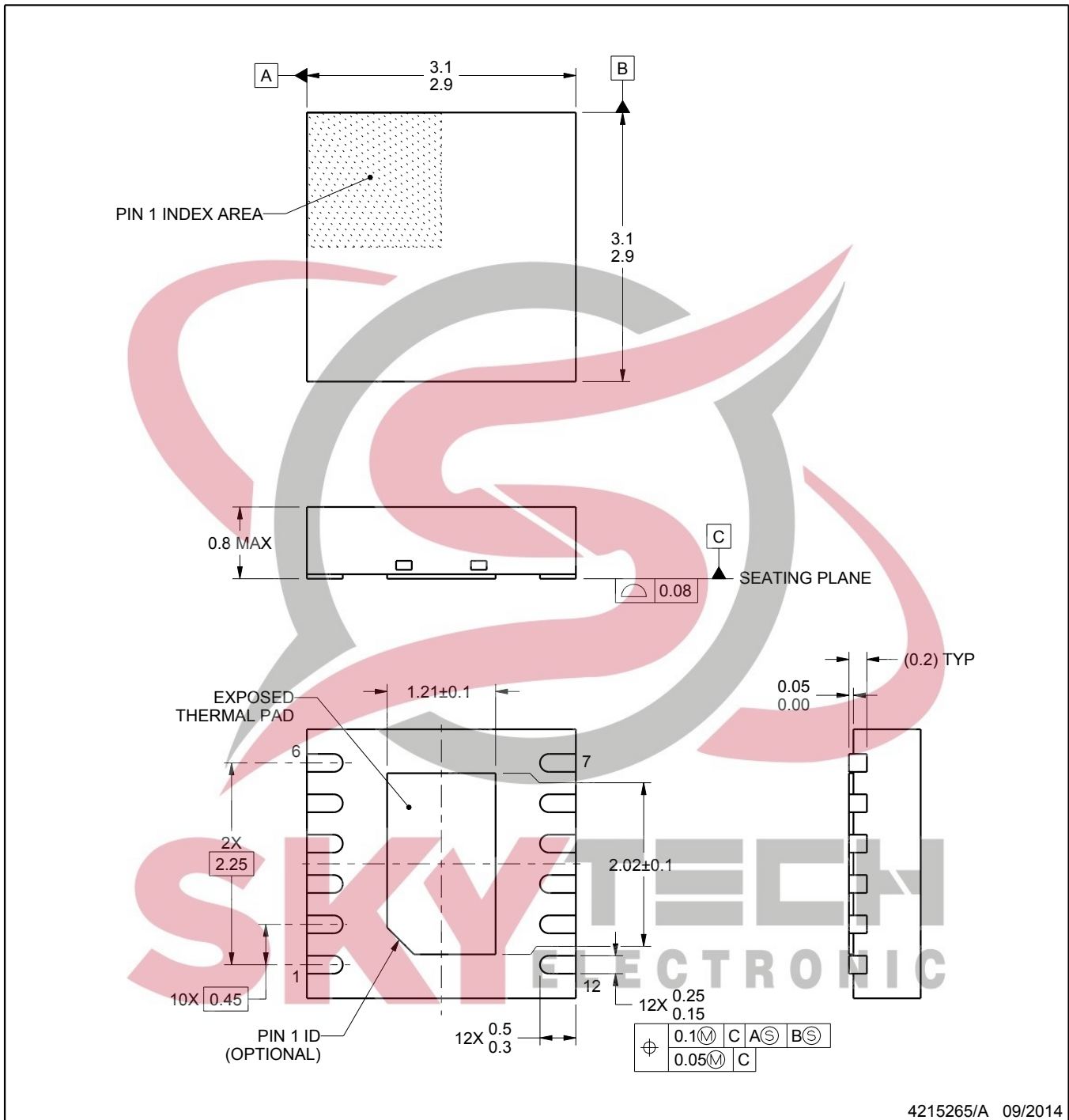

NOTES:

1. All linear dimensions are in millimeters. Any dimensions in parenthesis are for reference only. Dimensioning and tolerancing per ASME Y14.5M.
2. This drawing is subject to change without notice.
3. The package thermal pad must be soldered to the printed circuit board for thermal and mechanical performance.

EXAMPLE STENCIL DESIGN

DPD0012A

WSON - 0.8 mm max height

PLASTIC SMALL OUTLINE - NO LEAD

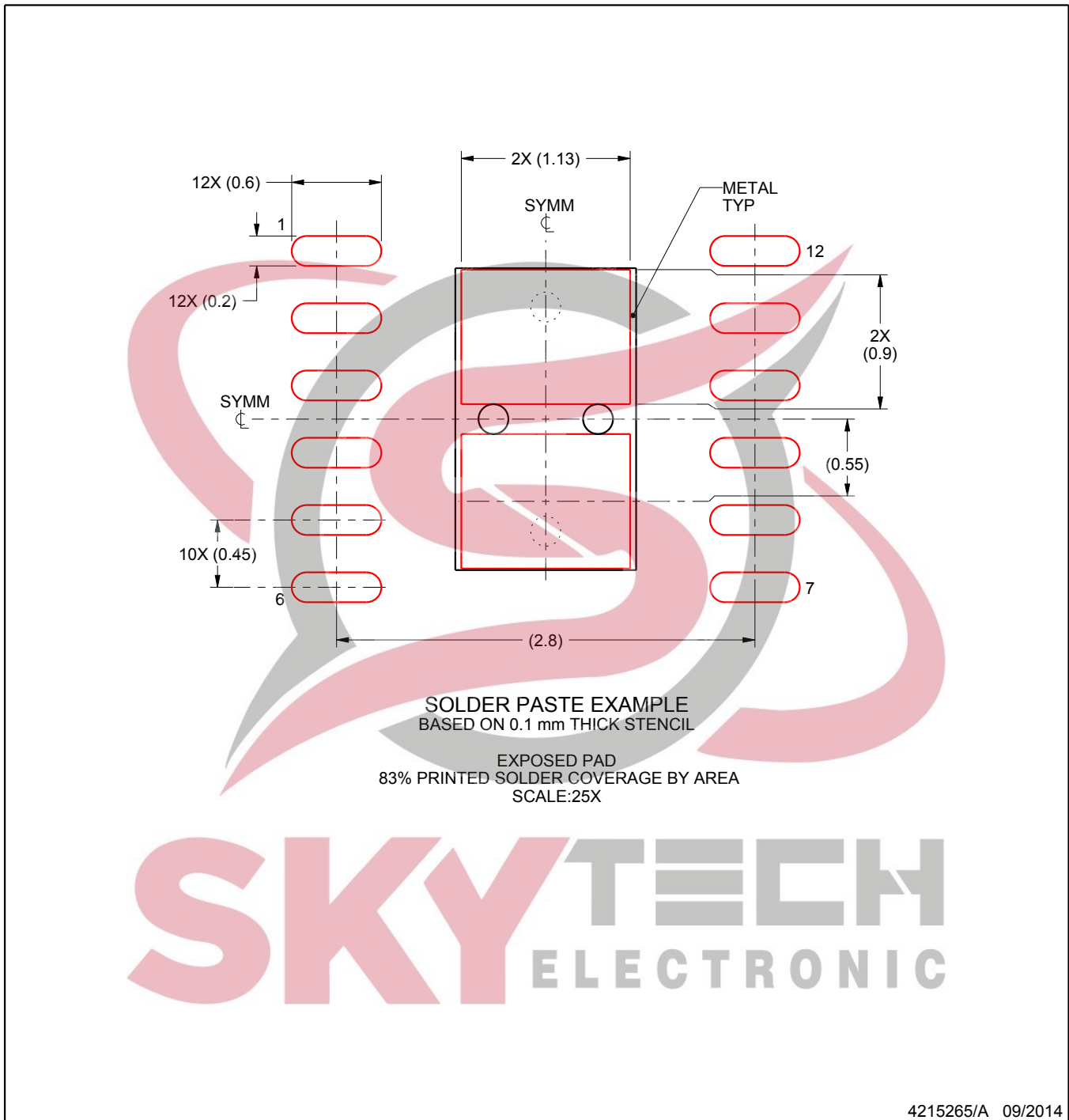

NOTES: (continued)

5. Laser cutting apertures with trapezoidal walls and rounded corners may offer better paste release. IPC-7525 may have alternate design recommendations.

PACKAGING INFORMATION

Orderable Device	Status (1)	Package Type	Package Drawing	Pins	Package Qty	Eco Plan (2)	Lead/Ball Finish (6)	MSL Peak Temp (3)	Op Temp (°C)	Device Marking (4/5)	Samples
TPS65133DPDR	ACTIVE	WSO8	DPD	12	3000	Green (RoHS & no Sb/Br)	NIPDAU	Level-2-260C-1 YEAR	-40 to 85	SHY	Samples

(1) The marketing status values are defined as follows:

ACTIVE: Product device recommended for new designs.

LIFEBUY: TI has announced that the device will be discontinued, and a lifetime-buy period is in effect.

NRND: Not recommended for new designs. Device is in production to support existing customers, but TI does not recommend using this part in a new design.

PREVIEW: Device has been announced but is not in production. Samples may or may not be available.

OBSELETE: TI has discontinued the production of the device.

(2) **RoHS:** TI defines "RoHS" to mean semiconductor products that are compliant with the current EU RoHS requirements for all 10 RoHS substances, including the requirement that RoHS substance do not exceed 0.1% by weight in homogeneous materials. Where designed to be soldered at high temperatures, "RoHS" products are suitable for use in specified lead-free processes. TI may reference these types of products as "Pb-Free".

RoHS Exempt: TI defines "RoHS Exempt" to mean products that contain lead but are compliant with EU RoHS pursuant to a specific EU RoHS exemption.

Green: TI defines "Green" to mean the content of Chlorine (Cl) and Bromine (Br) based flame retardants meet JS709B low halogen requirements of <=1000ppm threshold. Antimony trioxide based flame retardants must also meet the <=1000ppm threshold requirement.

(3) MSL, Peak Temp. - The Moisture Sensitivity Level rating according to the JEDEC industry standard classifications, and peak solder temperature.

(4) There may be additional marking, which relates to the logo, the lot trace code information, or the environmental category on the device.

(5) Multiple Device Markings will be inside parentheses. Only one Device Marking contained in parentheses and separated by a "~" will appear on a device. If a line is indented then it is a continuation of the previous line and the two combined represent the entire Device Marking for that device.

(6) Lead/Ball Finish - Orderable Devices may have multiple material finish options. Finish options are separated by a vertical ruled line. Lead/Ball Finish values may wrap to two lines if the finish value exceeds the maximum column width.

Important Information and Disclaimer:The information provided on this page represents TI's knowledge and belief as of the date that it is provided. TI bases its knowledge and belief on information provided by third parties, and makes no representation or warranty as to the accuracy of such information. Efforts are underway to better integrate information from third parties. TI has taken and continues to take reasonable steps to provide representative and accurate information but may not have conducted destructive testing or chemical analysis on incoming materials and chemicals. TI and TI suppliers consider certain information to be proprietary, and thus CAS numbers and other limited information may not be available for release.

In no event shall TI's liability arising out of such information exceed the total purchase price of the TI part(s) at issue in this document sold by TI to Customer on an annual basis.

TAPE AND REEL INFORMATION

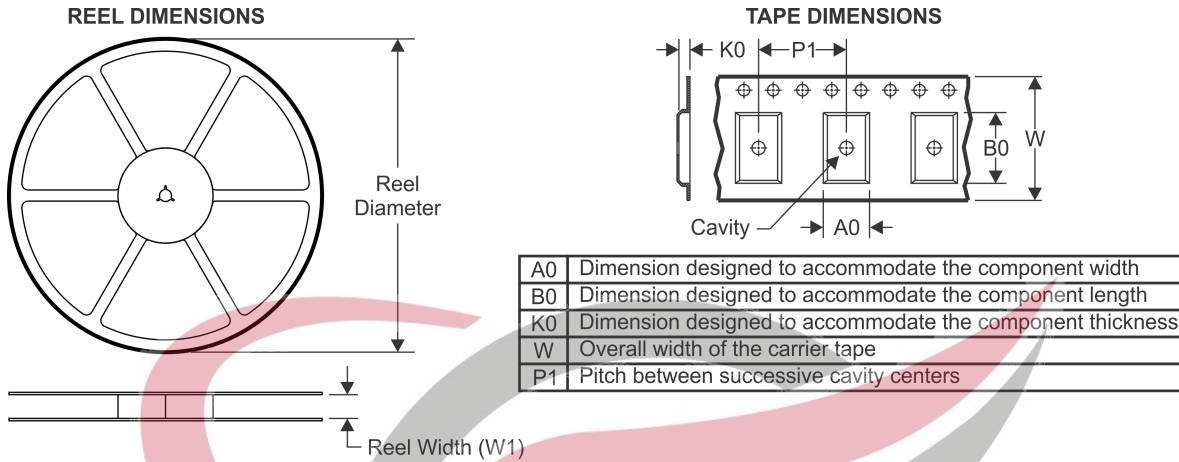

QUADRANT ASSIGNMENTS FOR PIN 1 ORIENTATION IN TAPE

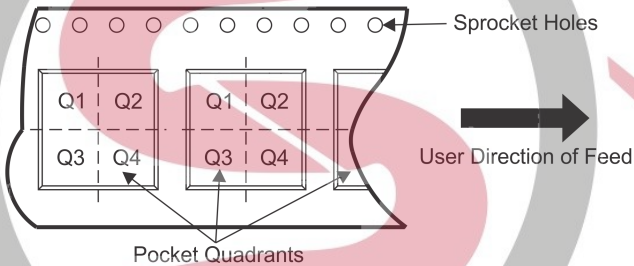

*All dimensions are nominal

Device	Package Type	Package Drawing	Pins	SPQ	Reel Diameter (mm)	Reel Width W1 (mm)	A0 (mm)	B0 (mm)	K0 (mm)	P1 (mm)	W (mm)	Pin1 Quadrant
TPS65133DPDR	WSON	DPD	12	3000	330.0	12.4	3.3	3.3	1.1	8.0	12.0	Q2



TAPE AND REEL BOX DIMENSIONS

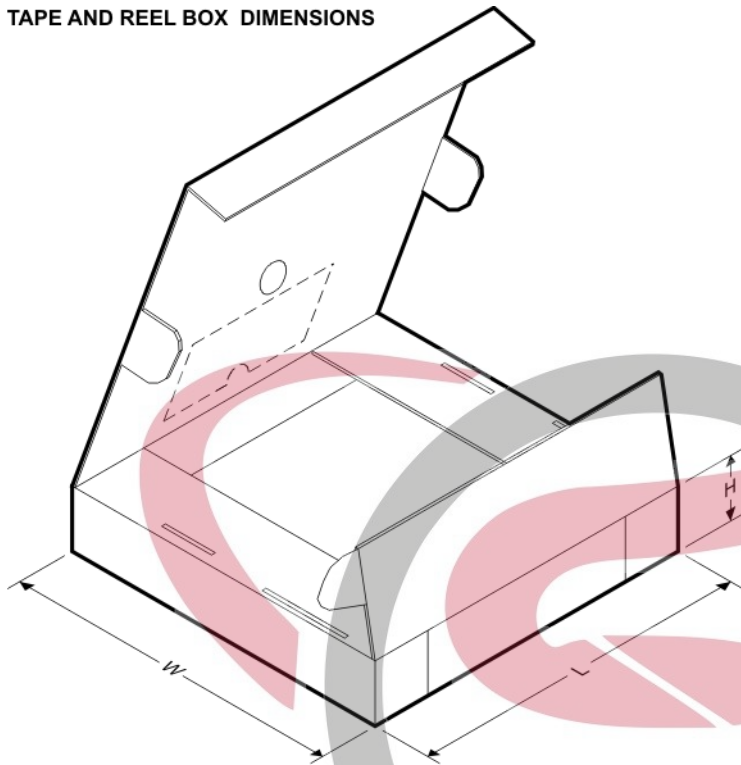

*All dimensions are nominal

Device	Package Type	Package Drawing	Pins	SPQ	Length (mm)	Width (mm)	Height (mm)
TPS65133DPDR	WSON	DPD	12	3000	367.0	367.0	35.0

SKYTECH
ELECTRONIC

DPD (S-PWSON-N12)

PLASTIC SMALL OUTLINE NO-LEAD

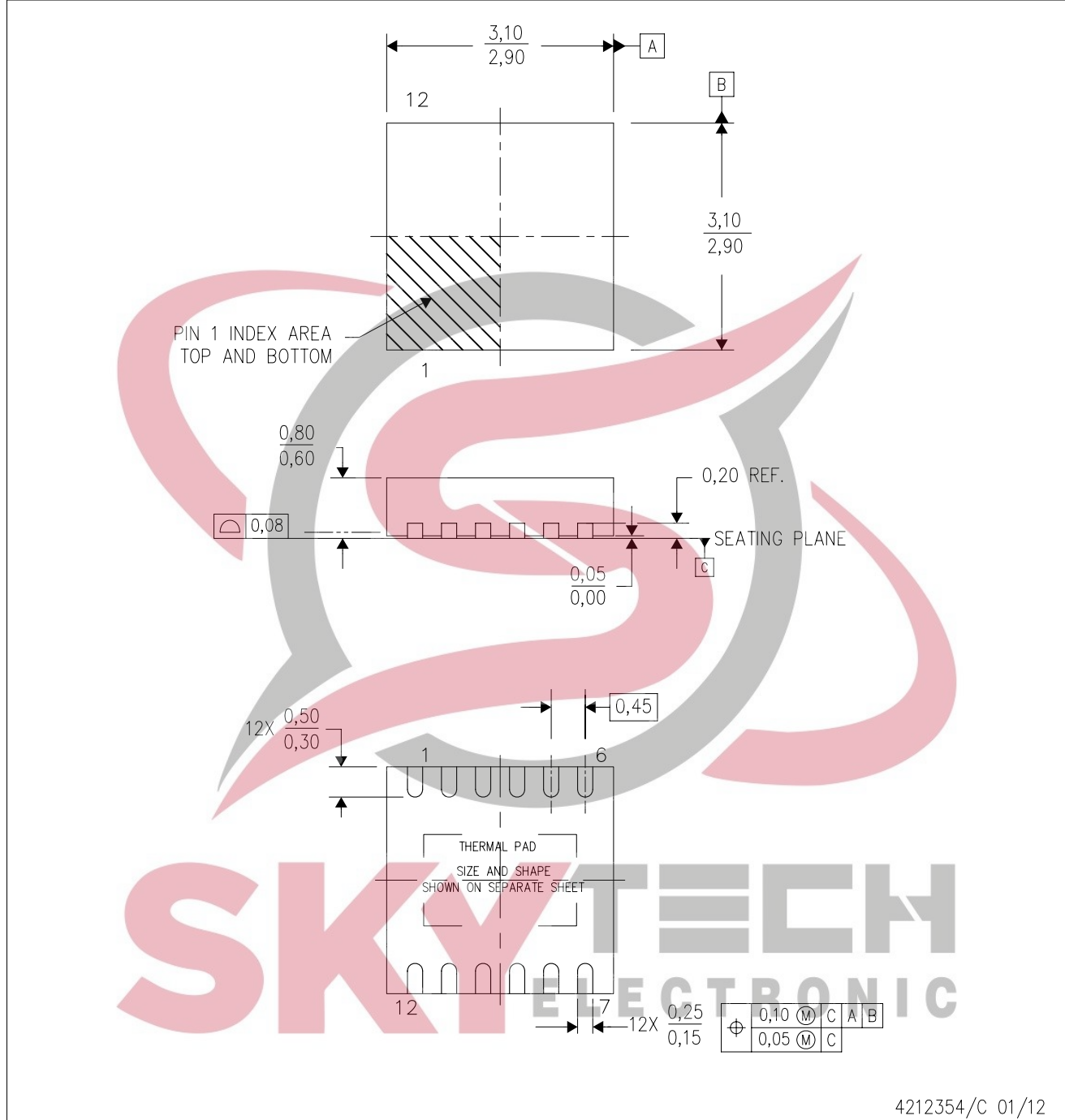

4212354/C 01/12

- NOTES:
- All linear dimensions are in millimeters. Dimensioning and tolerancing per ASME Y14.5M-1994.
 - This drawing is subject to change without notice.
 - Small Outline No-Lead (SON) package configuration.
 - The package thermal pad must be soldered to the board for thermal and mechanical performance, if present.
 - See the additional figure in the Product Data Sheet for details regarding the exposed thermal pad features and dimensions, if present.

THERMAL PAD MECHANICAL DATA

DPD (S-PUSON-N12)

PLASTIC SMALL OUTLINE NO-LEAD

THERMAL INFORMATION

This package incorporates an exposed thermal pad that is designed to be attached directly to an external heatsink. The thermal pad must be soldered directly to the printed circuit board (PCB). After soldering, the PCB can be used as a heatsink. In addition, through the use of thermal vias, the thermal pad can be attached directly to the appropriate copper plane shown in the electrical schematic for the device, or alternatively, can be attached to a special heatsink structure designed into the PCB. This design optimizes the heat transfer from the integrated circuit (IC).

For information on the Quad Flatpack No-Lead (QFN) package and its advantages, refer to Application Report, QFN/SOON PCB Attachment, Texas Instruments Literature No. SLUA271. This document is available at www.ti.com.

The exposed thermal pad dimensions for this package are shown in the following illustration.

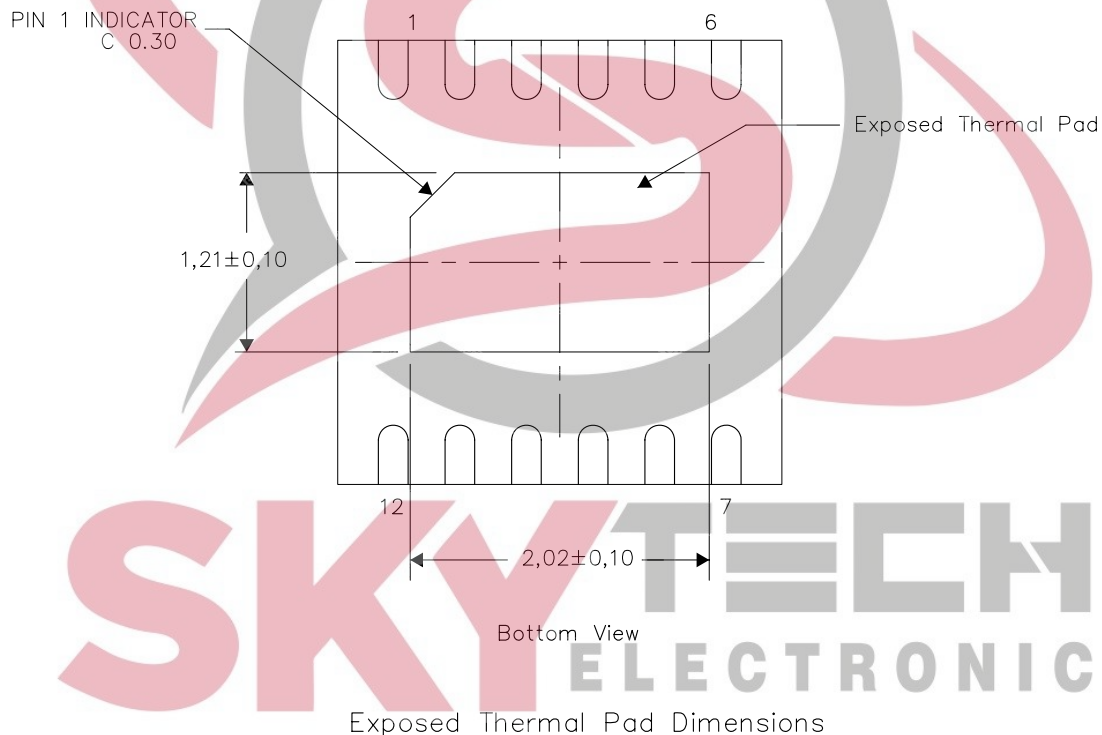

4212468/A 02/12

NOTE: All linear dimensions are in millimeters

IMPORTANT NOTICE AND DISCLAIMER

TI PROVIDES TECHNICAL AND RELIABILITY DATA (INCLUDING DATASHEETS), DESIGN RESOURCES (INCLUDING REFERENCE DESIGNS), APPLICATION OR OTHER DESIGN ADVICE, WEB TOOLS, SAFETY INFORMATION, AND OTHER RESOURCES "AS IS" AND WITH ALL FAULTS, AND DISCLAIMS ALL WARRANTIES, EXPRESS AND IMPLIED, INCLUDING WITHOUT LIMITATION ANY IMPLIED WARRANTIES OF MERCHANTABILITY, FITNESS FOR A PARTICULAR PURPOSE OR NON-INFRINGEMENT OF THIRD PARTY INTELLECTUAL PROPERTY RIGHTS.

These resources are intended for skilled developers designing with TI products. You are solely responsible for (1) selecting the appropriate TI products for your application, (2) designing, validating and testing your application, and (3) ensuring your application meets applicable standards, and any other safety, security, or other requirements. These resources are subject to change without notice. TI grants you permission to use these resources only for development of an application that uses the TI products described in the resource. Other reproduction and display of these resources is prohibited. No license is granted to any other TI intellectual property right or to any third party intellectual property right. TI disclaims responsibility for, and you will fully indemnify TI and its representatives against, any claims, damages, costs, losses, and liabilities arising out of your use of these resources.

TI's products are provided subject to TI's Terms of Sale (www.ti.com/legal/termsofsale.html) or other applicable terms available either on ti.com or provided in conjunction with such TI products. TI's provision of these resources does not expand or otherwise alter TI's applicable warranties or warranty disclaimers for TI products.

Mailing Address: Texas Instruments, Post Office Box 655303, Dallas, Texas 75265
Copyright © 2020, Texas Instruments Incorporated



SKYTECH
ELECTRONIC